

BASELIFT Corner 6301 / 6311

Wall-mounted or floor-mounted motorised corner worktop lift, 45° front edge, 90° wall

BASELIFT Corner 6301/6311 is a motorised corner worktop lift with 45° front edge and 90° rear edge. Choose between wall-mounted or floor-mounted motors.

Under the worktop, space is left for the knees and legs. Installations under the worktop, (motors, water, sewers), can be concealed by telescopic cover panels which gives the kitchen a neat look.

The motors work steplessly and adjust the worktop quickly and quietly to the desired height. The lift is equipped with a reliable safety system that guarantees safe operation without any risk of pinching. The lift is prepared in the factory to facilitate easy installation.



Corner worktop lift with 45° slanted front edge provides ample legroom under the worktop while providing good access to the work surfaces on the sides. Installations under the worktop are hidden by cover panels.



Inset sink with a sink bowl can be integrated with the corner module. It is also possible to integrate a hob with the corner module.



A drawer can be integrated with the worktop.



Functions and advantages

- Motorised corner worktop lift, 45° front edge, 90° wall
- Hob or sink bowl can be mounted in the corner module
- Height-adjustable 70-100 cm above the floor (excl. top board)
- The frame depth is adjustable 56-59 cm to fit adjoining cabinet
- The upper part of the lifting system is delivered ready-mounted. The sides are pre-assembled and adjustable side-ways to suit the sink, hob and drawers
- The lifting system is adjustable at an angle to compensate for an inclined wall
- Integrated safety switch
- 10 cm free space under motors for electrical installation and piping. (Applies to wall-mounted model)
- Choose floor-mounted model if there is no stable wall

Standard equipment

- Factory-mounted aluminium system with movable and tiltable brackets
- Wall-mounted or floor-mounted motors
- Safety switch

Recommended additional options

- Control button
- Front
- Hose cover/cover panels
- Sink (Not 6301L/6311L)
- Drawer (Not 6301L/6311L)
- Rear edge trim
- Top board
- Hob

Useful information

- Fittings for top board and fronts enclosed
- The top board's depth must be 15 mm shallower than adjoining top boards (to provide a gap for tiles and movement)
- Width of the top board = width of the lift
- Sink bowls with a maximum height of 120 mm can be integrated (Not 6301L/6311L)
- Electronics and motor system "Plug and Play"
- Width of front = width of lift - 4 mm
Height of front: 6301H/6311H = 103 mm, 6301L/6311L = 40 mm
Fittings enclosed
- Cover panels can hide installations under the worktop
2 pcs, height 438 mm, thickness 12-20 mm

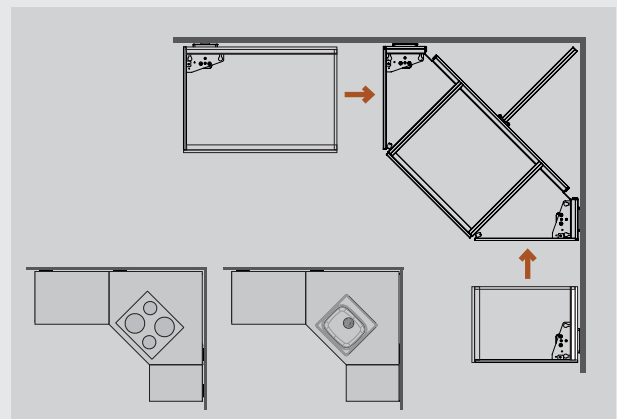

The corner module is equipped with two motors and can be used as one unit. Supplement with Plus modules to obtain the desired length on the left and right wings. A hob or sink bowl can be placed in the corner.

Specify the position of the drawers, sink and hob
The worktop is prepared in the factory. Drawers are mounted and sides assembled to facilitate the final mounting on the spot.

WALL-MOUNTED

6301H

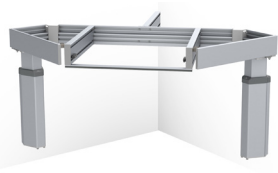

6301L



FLOOR-MOUNTED

6311H



6311L



Specifications

Mounting	Wall or floor
Corner solution	45° front edge, 90° wall
Height adjustment	Motorised, steplessly adjustable 300 mm (700-1000 mm excl. top board)
Speed	30 mm / sec.
Manoeuvring	Recessed mounted button or radio control
Safety	The safety strip is placed under the front edge of the worktop. If anything touches the safety strip, the lifting unit stops
Electricity connection	Plug for 230 V, max 5.0 A
Plumbing connections	Connection is made with flexible hoses
Lifting power	100 kg
IP Class	IP 20
Frame depth	560-590 mm from wall
Front height	40 or 103 mm
Dimensions cover panels	2 pcs, height 438 mm, thickness 12-20 mm
Width top board	Width = width of the lift
Depth top board	565-630 mm (15 mm shallower than worktops on fixed cabinets)
Gap to the side to wall/adjoining cabinet	5 mm
Gap to wall (for tiling)	15 mm
Tiling	From 700 mm above floor (alternatively all the way down to the floor)
Delivery modules	Ready-mounted worktop incl. safety switch, motors
Fittings enclosed	Bracket for fronts and top board
Material specifications	Aluminium frame
Guarantee	2 years
	CE

Measurement data

(mm)

WALL-MOUNTED: 6301H/6301L

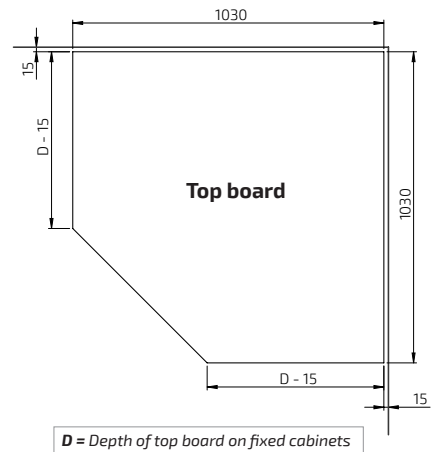
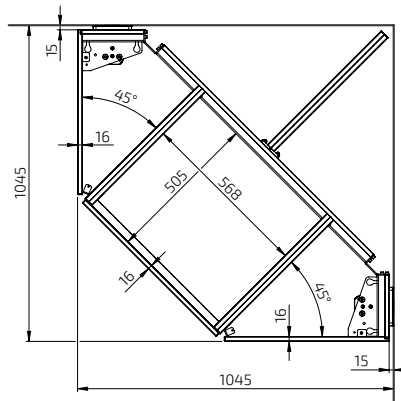
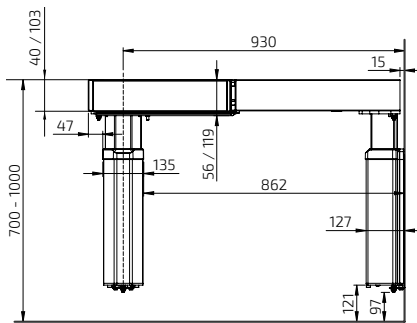

FLOOR-MOUNTED: 6311H / 6311L

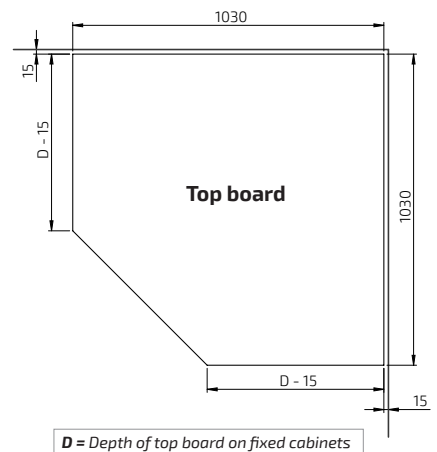
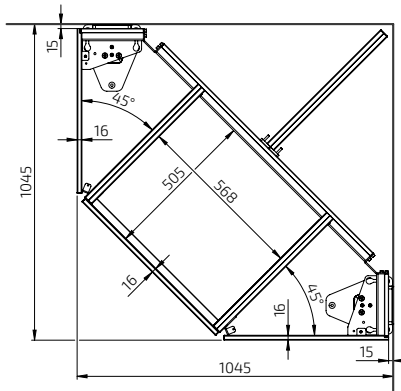
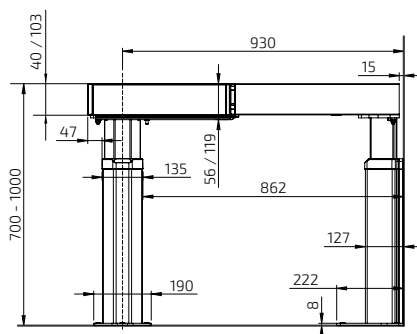

ORDERING INFORMATION

BASELIFT Corner 6301H/6311H

BASELIFT Corner 6301HA - Wall-mounted

Lifting unit 104.5 x 104.5 cm
For 103 mm front
Frame depth 56.0 - 59.0 cm
2 motors
Safety switch

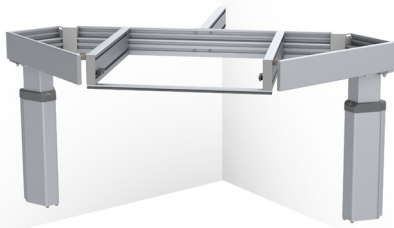

BASELIFT Corner 6311HA - Floor-mounted

Lifting unit 104.5 x 104.5 cm
For 103 mm front
Frame depth 56.0 - 59.0 cm
2 motors
Safety switch

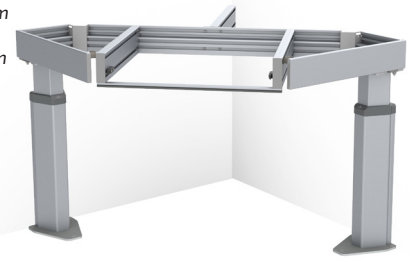

	Width (cm)	Art. no.
	104.5	6301HA-1045

Plus module Left 6305HA, 40.0-100.0 cm



	Width (cm)	Art. no.
	40.0	6305HA-040
	50.0	6305HA-050
	60.0	6305HA-060
	70.0	6305HA-070
	80.0	6305HA-080
	90.0	6305HA-090
	100.0	6305HA-100

	Width (cm)	Art. no.
	104.5	6311HA-1045

Plus module Left 6315HA, 40.0 - 100.0 cm



	Width (cm)	Art. no.
	40.0	6315HA-040
	50.0	6315HA-150
	60.0	6315HA-060
	70.0	6315HA-070
	80.0	6315HA-080
	90.0	6315HA-090
	100.0	6315HA-100

Plus module Left 6305HA, 110.0-180.0 cm



	Width (cm)	Art. no.
	110.0	6305HA-110
	120.0	6305HA-120
	130.0	6305HA-130
	140.0	6305HA-140
	150.0	6305HA-150
	160.0	6305HA-160
	170.0	6305HA-170
	180.0	6305HA-180

Plus module Left 6315HA, 110.0 - 180.0 cm



	Width (cm)	Art. no.
	110.0	6315HA-110
	120.0	6315HA-120
	130.0	6315HA-130
	140.0	6315HA-140
	150.0	6315HA-150
	160.0	6315HA-160
	170.0	6315HA-170
	180.0	6315HA-180

Plus module Left 6305HA, 190.0-240.0 cm



	Width (cm)	Art. no.
	190.0	6305HA-190
	200.0	6305HA-200
	210.0	6305HA-210
	220.0	6305HA-220
	230.0	6305HA-230
	240.0	6305HA-240

Plus module Left 6315HA, 190.0 - 240.0 cm



	Width (cm)	Art. no.
	190.0	6315HA-190
	200.0	6315HA-200
	210.0	6315HA-210
	220.0	6315HA-220
	230.0	6315HA-230
	240.0	6315HA-240

Plus module Right 6306HA, 40.0-100.0 cm



	Width (cm)	Art. no.
	40.0	6306HA-040
	50.0	6306HA-050
	60.0	6306HA-060
	70.0	6306HA-070
	80.0	6306HA-080
	90.0	6306HA-090
	100.0	6306HA-100

Plus module Right 6316HA, 40.0 - 100.0 cm



	Width (cm)	Art. no.
	40.0	6316HA-040
	50.0	6316HA-050
	60.0	6316HA-160
	70.0	6316HA-070
	80.0	6316HA-080
	90.0	6316HA-090
	100.0	6316HA-100

Plus module Right 6306HA, 110.0 - 180.0 cm



	Width (cm)	Art. no.
	110.0	6306HA-110
	120.0	6306HA-120
	130.0	6306HA-130
	140.0	6306HA-140
	150.0	6306HA-150
	160.0	6306HA-160
	170.0	6306HA-170
	180.0	6306HA-180

Plus module Right 6316HA, 110.0 - 180.0 cm



	Width (cm)	Art. no.
	110.0	6316HA-110
	120.0	6316HA-120
	130.0	6316HA-130
	140.0	6316HA-140
	150.0	6316HA-150
	160.0	6316HA-160
	170.0	6316HA-170
	180.0	6316HA-180

Plus module Right 6306HA, 190.0 - 180.0 cm

















	Width (cm)	Art. no.
	190.0	6306HA-190
	200.0	6306HA-200
	210.0	6306HA-210
	220.0	6306HA-220
	230.0	6306HA-230
	240.0	6306HA-240

Plus module Right 6316HA, 190.0 - 240.0 cm

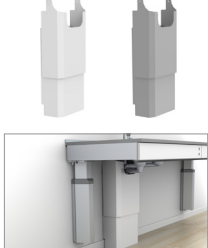
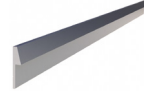

	Width (cm)	Art. no.
	190.0	6316HA-190
	200.0	6316HA-200
	210.0	6316HA-210
	220.0	6316HA-220
	230.0	6316HA-230
	240.0	6316HA-240

	<p>Control button in ALU-design Wired, for recessed mounting Dimensions: 82 x 82 x 17 mm</p>	61320
	<p>Control button, Mini Wired, for recessed mounting Diameter: 20 mm</p>	61318
	<p>Radio control - Hand control Dimensions: 38 x 110 x 10 mm</p> <p>For one lift</p> <p>For two lifts</p> <p>For three lifts</p> <p>For four lifts</p> <p>For five lifts</p>	61385
		61387
		61388
		61389
		61390
	<p>Multi-compartment frame, ALU-design Collects power socket, power switch or control buttons in a multi-compartment frame.</p> <p>Two-compartment frame: 153 x 82 x 9 mm</p> <p>Three-compartment frame: 225 x 82 x 9 mm</p>	61352 61353
	<p>Socket, ALU-design Earthed socket 230 V with flap cover. Dimensions: 82 x 82 x 17 mm Only Europe</p>	61330
	<p>Power switch, ALU-design For lighting, for example. The button has a sign for optional marking. Dimensions: 82 x 82 x 17 mm</p>	61331
	<p>Safety lock Prevents unauthorised use. Dimensions: 23 x 9 mm</p>	61360
	<p>Front, white-lacquered aluminium Replace xxx with cm when ordering. Example, 385H-040-01 for 40.0 cm</p> <p>Lacquered aluminium, white RAL 9003 Height: 103 mm Optional length, 20.0-340.0 cm</p>	385H-xxx-01
	<p>Front, anodised aluminium Replace xxx with cm when ordering. Example, 385H-040-06 for 40.0 cm</p> <p>Anodised aluminium Height: 103 mm Optional length, 20.0-340.0 cm</p>	385H-xxx-06
	<p>Integrated drawer with full extension and soft-close or push-to-open function Depth: 470 mm, height: 85 mm Colour: Anthracite (RAL 9004)</p>	465H-030 465H-040 465H-050 465H-060 465H-080 466H-030 466H-040 466H-050 466H-060 466H-080

	<p>Cutlery compartment</p> <p>Fits 30.0 cm wide drawer</p> <p>Fits 40.0 cm wide drawer</p> <p>Fits 50.0 cm wide drawer</p> <p>Fits 60.0 cm wide drawer</p> <p>Fits 80.0 cm wide drawer</p>	463-030 463-040 463-050 463-060 463-080
	<p>Safety strip Used if pinch protection is desired on the gable end (by an open side). Length: 370 mm, Height: 10 mm</p>	61430
	<p>Safety panel, short end Used when the worktop lift's underside passes over adjoining furnishings. Height: 263 - 800 mm, Depth: 400 mm For a worktop lift with cover panels</p>	Left 61442 Right 61443
	<p>Safety panel, short end Used when the worktop lift's underside passes over adjoining furnishings. Height: 263 - 800 mm, Depth: 545 mm For a worktop lift without cover panels</p>	Left 61444 Right 61445
	<p>Hob cover under worktop lift Provides a smooth underside. Used under the hob.</p> <p>White-lacquered metal RAL 9003</p>	60.0 cm 6266-060 70.0 cm 6266-070 80.0 cm 6266-080 90.0 cm 6266-090 100.0 cm 6266-100
	<p>Cover panels Used to cover installations under the worktop.</p> <p>12 mm white melamine, 2 pcs height 438 mm 2 pcs are required for lengths over 2400 mm</p>	6260-240
	<p>Fittings set for cover panels Used to mount cover panels that conceal installations under the worktop.</p> <p>Colour: Alu-grey RAL 9006 2 pcs are required for lengths over 2400 mm</p>	6260-005
	<p>Hose cover The hose cover is mounted anywhere under the worktop, (next to motors, if applicable) to provide a neat coverage of hoses when the cover panels are not in use. Fittings are included.</p> <p>Width: 410 mm, Depth: 200 mm</p>	White plastic 61504-01 Grey plastic 61504-06
	<p>Rear edge trim in aluminium for top board Mounted behind top board. Brushed aluminium Height above top board: 20 mm Thickness behind top board: 3 mm (per metre)</p>	6943-06
	<p>Height-adjustment kit Used to change stroke after installation. Contains programming box and memory adapter.</p>	61400

BASELIFT Corner 6301LA - Wall-mounted

Lifting unit 104.5 x 104.5 cm
 For 40 mm front
 Frame depth 56.0 - 59.0 cm
 2 motors
 Safety switch



BASELIFT Corner 6311LA-Floor-mounted

Lifting unit 104.5 x 104.5 cm
 For 40 mm front
 Frame depth 56.0-59.0 cm
 2 motors
 Safety switch



	Width (cm)	Art. no.
	104.5	6301LA-1045

	Width (cm)	Art. no.
	104.5	6311LA-1045

Plus module Left 6305LA, 40.0-100.0 cm



40.0	6305LA-040
50.0	6305LA-050
60.0	6305LA-060
70.0	6305LA-070
80.0	6305LA-080
90.0	6305LA-090
100.0	6305LA-100

Plus module Left 6315LA, 40.0 - 100.0 cm



40.0	6315LA-040
50.0	6315LA-150
60.0	6315LA-060
70.0	6315LA-070
80.0	6315LA-080
90.0	6315LA-090
100.0	6315LA-100

Plus module Left 6305LA, 110.0-180.0 cm



110.0	6305LA-110
120.0	6305LA-120
130.0	6305LA-130
140.0	6305LA-140
150.0	6305LA-150
160.0	6305LA-160
170.0	6305LA-170
180.0	6305LA-180

Plus module Left 6315LA, 110.0 - 180.0 cm



110.0	6315LA-110
120.0	6315LA-120
130.0	6315LA-130
140.0	6315LA-140
150.0	6315LA-150
160.0	6315LA-160
170.0	6315LA-170
180.0	6315LA-180

Plus module Left 6305LA, 190.0-240.0 cm



190.0	6305LA-190
200.0	6305LA-200
210.0	6305LA-210
220.0	6305LA-220
230.0	6305LA-230
240.0	6305LA-240

Plus module Left 6315LA, 190.0 - 240.0 cm



190.0	6315LA-190
200.0	6315LA-200
210.0	6315LA-210
220.0	6315LA-220
230.0	6315LA-230
240.0	6315LA-240

Plus module Right 6306LA, 40.0 - 100.0 cm



40.0	6306LA-040
50.0	6306LA-050
60.0	6306LA-060
70.0	6306LA-070
80.0	6306LA-080
90.0	6306LA-090
100.0	6306LA-100

Plus module Right 6316LA, 40.0 - 100.0 cm



40.0	6316LA-040
50.0	6316LA-050
60.0	6316LA-160
70.0	6316LA-070
80.0	6316LA-080
90.0	6316LA-090
100.0	6316LA-100

Plus module Right 6306LA, 110.0 - 180.0 cm



110.0	6306LA-100
120.0	6306LA-120
130.0	6306LA-130
140.0	6306LA-140
150.0	6306LA-150
160.0	6306LA-160
170.0	6306LA-170
180.0	6306LA-180

Plus module Right 6316LA, 110.0 - 180.0 cm



110.0	6316LA-110
120.0	6316LA-120
130.0	6316LA-130
140.0	6316LA-140
150.0	6316LA-150
160.0	6316LA-160
170.0	6316LA-170
180.0	6316LA-180

Plus module Right 6306LA, 190.0 - 240.0 cm

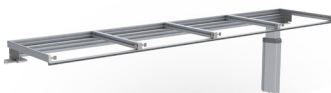











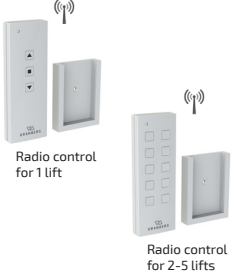

190.0	6306LA-190
200.0	6306LA-200
210.0	6306LA-210
220.0	6306LA-220
230.0	6306LA-230
240.0	6306LA-240

Plus module Right 6316LA, 190.0 - 240.0 cm

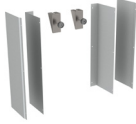
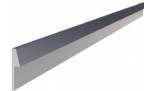

190.0	6316LA-190
200.0	6316LA-200
210.0	6316LA-210
220.0	6316LA-220
230.0	6316LA-230
240.0	6316LA-240

 <p>Control button, Mini Wired, for recessed mounting Diameter: 20 mm</p>	<p>61318</p>	 <p>Safety strip Used if pinch protection is desired on the gable end (by an open side). Length: 370 mm Height: 10 mm</p>	<p>61430</p>
 <p>Radio control - Hand control Dimensions: 38 x 110 x 10 mm</p> <p>For one lift</p> <p>For two lifts</p> <p>For three lifts</p> <p>For four lifts</p> <p>For five lifts</p>	<p>61385</p> <p>61387</p> <p>61388</p> <p>61389</p> <p>61390</p>	 <p>Safety panel, short end Used when the worktop lift's underside passes over adjoining interior fittings. Height: 263 mm, Depth: 400 mm For a worktop lift with cover panels</p> <p>Left</p> <p>Right</p>	<p>61442</p> <p>61443</p>
 <p>Safety lock Prevents unauthorised use. Dimensions: 23 x 9 mm</p>	<p>61360</p>	 <p>Safety panel, short end Used when the worktop lift's underside passes over adjoining furnishings. Height: 263 mm, Depth: 545 mm For a worktop lift without cover panels</p> <p>Left</p> <p>Right</p>	<p>61444</p> <p>61445</p>
 <p>Front, white-lacquered aluminium Replace xxx with cm when ordering. Example, 385L-040-01 for 40.0 cm</p> <p>Lacquered aluminium, white RAL 9003 Height: 40 mm Optional length, 20.0-340.0 cm</p>	<p>385L-xxx-01</p>	 <p>Hob cover under worktop lift Provides a smooth underside. Used under the hob.</p> <p>White-lacquered metal RAL 9003</p> <p>60.0 cm</p> <p>70.0 cm</p> <p>80.0 cm</p> <p>90.0 cm</p> <p>100.0 cm</p>	<p>6266-060</p> <p>6266-070</p> <p>6266-080</p> <p>6266-090</p> <p>6266-100</p>
 <p>Front, anodised aluminium Replace xxx with cm when ordering. Example, 385L-040-06 for 40.0 cm</p> <p>Anodised aluminium Height: 40 mm Optional length, 20.0-340.0 cm</p>	<p>385L-XXX-06</p>	 <p>Cover panels Used to cover installations under the worktop.</p> <p>Length is adapted to worktop lift's length.</p> <p>12 mm white melamine, 2 pcs height 438 mm 2 pcs are required for lengths over 2400 mm</p>	<p>6260-240</p>
 <p>Fittings set for cover panels Used to mount cover panels that conceal installations under the worktop.</p> <p>Colour: Alu-grey RAL 9006 2 pcs are required for lengths over 2400 mm</p>	<p>6260-005</p>	 <p>Rear edge trim in aluminium for top board Mounted behind top board. Brushed aluminium Height above top board: 20 mm Thickness behind top board: 3 mm (per metre)</p>	<p>6943-06</p>
 <p>Height-adjustment kit Used to change stroke after installation. Contains programming box and memory adapter.</p>	<p>61400</p>		